



High Rise Shower

Installation Guide

Thank you for purchasing this Par Taps product



designed and built
in australia

Important Information

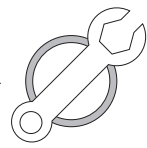

Prior to Installation:

- Please read these instructions completely.
- Ensure water supply lines are closed.
- All instructions serve as a guide only and must be installed by a licensed plumber. Installation carried out by unlicensed individuals will void all warranties.
- Supply lines must be flushed prior to installation to remove any foreign matter.
- Stop Valves must be installed in accordance with regulatory authorities' guidelines.
- All products are suitable for use with most instantaneous hot water heaters, however are not compatible with gravity-fed water systems.
- Once installation is complete, please check all joints and connections for leaks

Water Pressure & Temperature:

This Par Taps products are to be installed by a Licensed Plumber in accordance with AS/NZS 3500.1

Maximum Water Temperature ----- 80° Celsius

Maximum Water Pressure ----- 1600kPa

Regulatory Maximum Water Pressure ----- 500kPa

Note: In areas where the recommended maximum water pressure is exceeded, pressure-limiting valves must be installed.

Part List

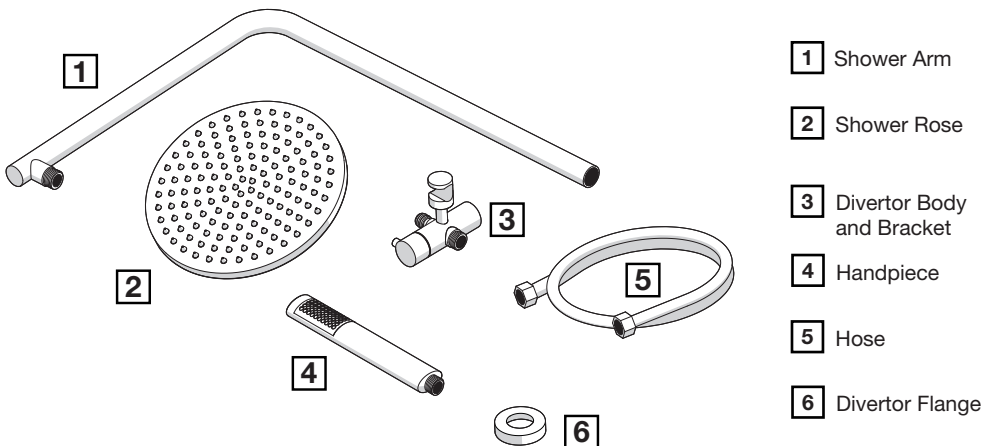

Installation

1. Using a spanner, screw the Push-fit connector to the 1/2 thread.

2. Push-fit the Divertor Body (3) onto the connection and tighten both grub screws on top and below the body.

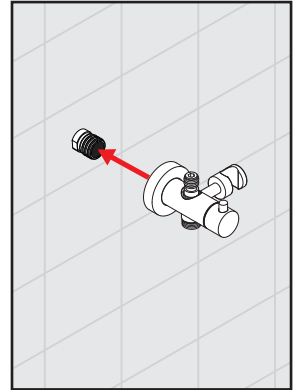
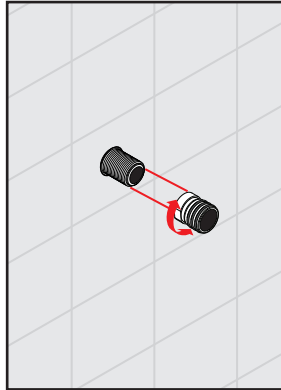
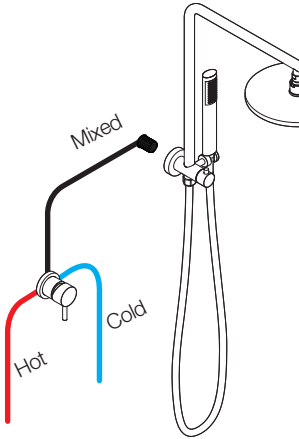

3. Push fit the Shower Arm (1) onto the nipple of the Divertor Body (3). Tighten the grub screw to secure the arm to the nipple.

4. Screw the Shower Rose (2) to the Arm (1) and tighten with a spanner.

5. Attach the Hose (5) to the Handpiece (4) the tighten to the base of the Divertor Body (3).

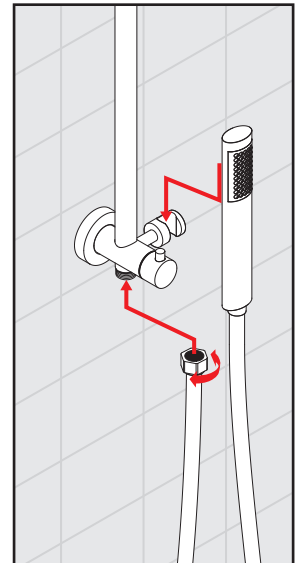
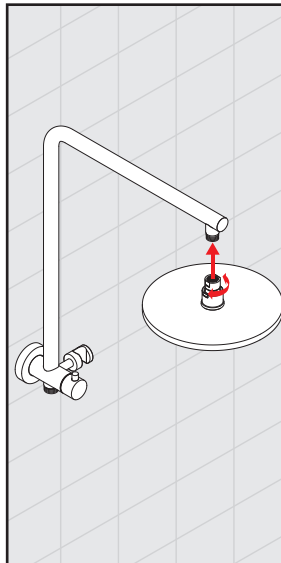
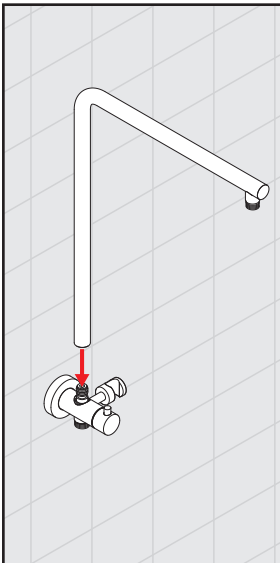

Warranty

Our goods come with guarantees that cannot be excluded under the Australian Consumer Law. You are entitled to a replacement or refund for a major failure and for compensation for any other reasonably foreseeable loss or damage. You are also entitled to have the goods repaired or replaced if the goods fail to be of acceptable quality and the failure does not amount to a major failure.

Par Taps' warranty covers the repair and/or replacement of any product which is defective through faulty workmanship or faulty materials. Our warranty is in addition to other rights and remedies available to the customer under law. The warranty period commences from date of purchase. In order to make a warranty claim you must follow the steps listed below. Your claim will then be considered and processed. Please note that you are responsible for the cost of returning the goods to Par Taps unless this involves unreasonable cost in which case Par Taps will make necessary arrangements for collection/inspection. Par Taps will decide the steps necessary to rectify the problem which may involve a repair, a replacement or a refund. Par Taps will not be liable for any claim/s for labour, additional products or parts associated with alleged faulty product or for work not approved by Par Taps save for those covered by the Australian Consumer Law. Should a warranty claim be made and attended to by a Par Taps service agent and the fault is deemed to be due to an improper installation or due to other goods used in conjunction with the goods, Par Taps reserves the right to charge a call out fee and, if the service agent repairs the product, an additional service fee will be payable by the owner of the residence where the goods have been installed.

To the extent permitted by law, Par Taps will not be liable for any loss or damage to furniture, floor coverings, walls, fixtures or any other consequential loss of any kind caused by any defect in the products or components. Any warranty shall be void due to any of the following occurring:

- Products not installed by a licensed plumber.
- The inability to provide proof of purchase or documents with the adequate information
- Tapware exposed to water pressures and or temperatures that exceed stated limitations as per the product
- Installation instructions
- Isolation stop valves not fitted as stated on installation instructions
- Products not installed in accordance with the manufacturer's installation instructions
- Products used for incorrect applications, non-potable water etc
- Damage as a result of debris/particles due to inadequate flushing of system prior to installation
- Failure to clean and/or replace aerator insert
- Damage to finishes by abrasive chemicals, sealants etc
- Damage to finishes during installation or post installation
- Failure to observe manufacturer's care and cleaning instructions.

Custom Made or Finished Products

Par Taps Pty Ltd offers a custom made service whereby many products can be manufactured to suit your clients needs including sizing changes and also a variety of coated or natural finishes. As the variety is great we encourage you to contact our office by either email or fax with an accurate diagram and/or description of the particular product / s you do require and we shall advise you if the work is within our parameters and also your nett pricing for the custom made product/s. A minimum of 30 working days is required to complete the product/s excluding shipping time. Under no circumstances are the custom made products or finishes available for credit or return.

Par Taps' Domestic Warranty Period on all purchases from 1 March 2016

| | |
|-----------------------------|-----------------------------------------------------------------------------------------------------------------------------------------------------------------------------------------------|
| Tapware & Mixers | 10 years Ceramic Disc Cartridge Part only 10 years Replacement part/s excluding general wear & tear 1 year labour *Excludes Jumper Valves, O-rings and washers & General wear & tear |
|-----------------------------|-----------------------------------------------------------------------------------------------------------------------------------------------------------------------------------------------|

| | |
|--------------------|-----------------------------------------------------|
| Accessories | 1 year replacement part/s 1 year replacement part/s |
|--------------------|-----------------------------------------------------|

| | |
|-----------------|------------------------------------------------------------------------------------------------------------------------------------------------------------------------------------------------------------------------------------------------------------------------------------|
| Finishes | 1 year replacement part/s only (Every finish except for Chrome is considered an Other Finish) Excludes any finishes that will naturally patina with time.* *Antique Bronze, Native Brass, Polished Brass, Brass Gold, Copper, Antique Copper, Rumbled Brass and Raw Brass |
|-----------------|------------------------------------------------------------------------------------------------------------------------------------------------------------------------------------------------------------------------------------------------------------------------------------|

Commercial warranty is limited to a total of 1 year & is parts only.

Commercial warranty is anything other than a domestic or residential property.

Warranty Contact Details:

All claims are to be made to Par Taps Pty Ltd by either email, fax or mail, with a description of the alleged fault together with proof of purchase, the delivery docket with the purchase order (available from the store the goods were purchased from, details of the licensed plumber who installed the goods where Applicable.) Please forward all the required details to;

Par Taps Pty Ltd

25 – 27 Bellevue Crescent Preston, VIC 3072

p: 03 9484 0960

e: service@partaps.com.au